

Place tube flush with top of chord

This line of fasteners may be 14AMS.75 from each side or 14AMDR2.375 from one side (See General Note #2)

63W1.5x3.5 1.5x3.5-63-45KSI
20" (508mm) tube insert
Center tube on splice

TSC4.00

1-3/8"
(35mm)

ϕ

3 spaces @ 3/4" (19mm) each

Detail "O"

4 spaces @ 3/4" (19mm) each

Detail "P"

5 spaces @ 3/4" (19mm) each

Detail "Q"

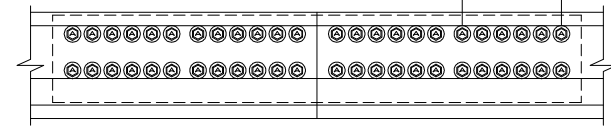
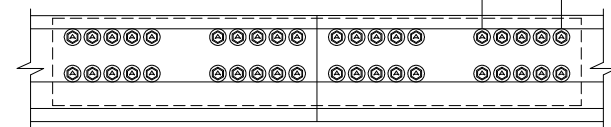
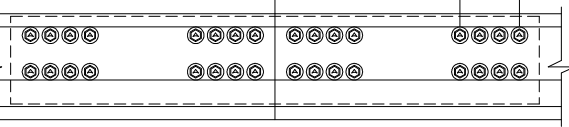
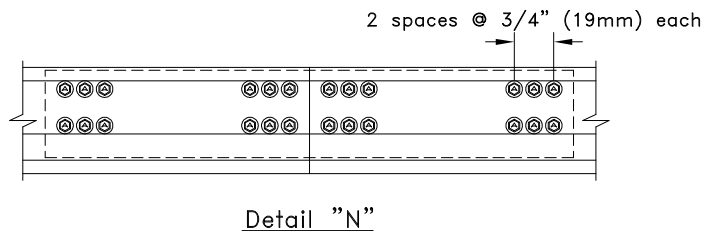
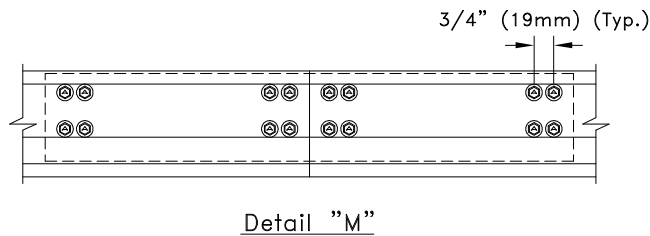
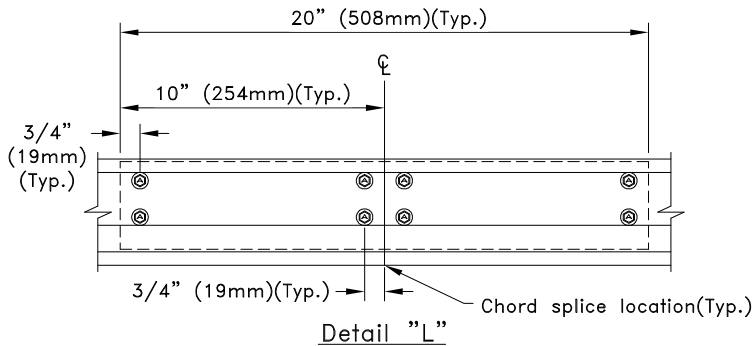

General Notes:

1. Fastener spacing and end distance is 3/4" (19mm) minimum.
2. Fasteners may be 14AMS.75 or 14AMDR2.375 (14AMDB2.125 fasteners may be substituted for 14AMDR2.375 fasteners when the chord is 22g, 20g, 18g, or 16g). Refer to approved truss drawings for fastener type and detail call out.
3. Dimensions are typical for both sides of splice per splice detail.

ALPINE TrusSteel[®]

Division of ITW Building Components Group, Inc.

www.TrusSteel.com

Florida: 1950 Marley Drive / Haines City, FL 33844 / (800) 755-6001
Missouri: 13389 Lakefront Drive / Earth City, MO 63045 / (800) 326-4102
California: 8351 Rovana Circle / Sacramento, CA 95828 / (800) 877-3678

TSC4.00 Splices Using The
"Tube Only" Splice

ITW Building Components Group, Inc. shall not be responsible for any performance failure in a connection due to a deviation from this detail. Any variation from this detail shall be approved in advance by ITW Building Components Group, Inc.

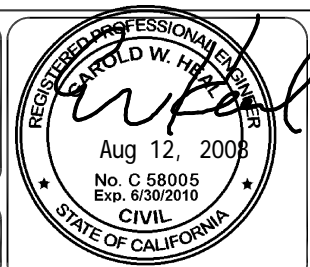

Standard Detail:

TS012A

Date:

06/25/07

TrusSteel Detail Category:

Chord Splices